

# BURY CP 1000 CarPhone

## Index

|   |           |
|---|-----------|
| <b>Introductory information</b>   | <b>2</b>  |
| 1. General  | 2         |
| 2. Security guidelines  | 2         |
| <b>Installation of the system</b>                                       | <b>6</b>  |
| 3. Scope of supply  | 6         |
| 4. Positioning and mounting   | 8         |
| 5. Plug the cable for the BURY CP 1000 CarPhone into the electronic box | 11        |
| 6. Connections on the electronics box                                   | 12        |
| <b>Operating guidelines</b>   | <b>15</b> |
| 7. Using the BURY CP 1000 CarPhone for the first time                   | 15        |
| 8. Handling possibilities   | 17        |
| 9. Voice control  | 17        |
| 10. Operating the menu using the keypad                                 | 18        |
| 11. Menu navigation   | 19        |
| 12. Accepting, making, ending calls                                     | 29        |
| <b>Further Information</b>  | <b>30</b> |
| 13. Service   | 30        |
| 14. Approvals and declaration of conformity                             | 31        |

## 1. General

### Dear customer,

Congratulations on purchasing the BURY CP 1000 CarPhone. You have chosen a high quality product that is extremely easy to use.

Please read the operating manual carefully so that you can fully enjoy your BURY CP 1000 CarPhone. If you have any further questions concerning installation or operation of your car telephone, please contact your dealer. He will be happy to give you reliable advice.

You can also contact our hotline. Our phone and fax numbers are listed in the chapter Service at the end of the operating instructions.

### Have a good trip!

## 2. Security guidelines

- ▶ Read the Safety Information on this guide on page 2-5



- ▶ Small parts may cause a choking hazard



- ▶ This device may produce a loud sound



- ▶ Switch off in explosive environments
- ▶ In locations with potentially explosive atmospheres, obey all posted signs to turn off devices such as your phone or other radio equipment



- ▶ Do not dispose of in a fire
- ▶ Do not expose your phone or its accessories to open flames or lit tobacco products



- ▶ Avoid contact with magnetic media
- ▶ To avoid the risk of demagnetisation, do not allow electronic devices or magnetic media close to your phone for a long time



- ▶ Avoid Extreme Temperatures
- ▶ Do not expose your phone or its accessories to extreme temperatures, minimum – 10 and maximum + 55 degrees Celsius



- ▶ Avoid contact with liquid, keep dry
- ▶ Do not expose your phone or its accessories to liquid, moisture or high humidity
- ▶ Do not use harsh chemicals, cleaning solvents, or aerosols to clean the device or its accessories



- ▶ Do not try and disassemble
- ▶ Only qualified personnel must service or repair the phone or its accessory



- ▶ Do not rely on this device for emergency communications



- ▶ Only use approved accessories
- ▶ Do not connect with incompatible products or accessories



## RF Exposure

Your phone contains a transmitter and a receiver. When it is ON, it receives and transmits RF energy. When you communicate with your phone, the system handling your call controls the power level at which your phone transmits. To ensure compliance with RF exposure guidelines the phone must be used with a minimum of 30 cm separation from the body.

## Specific Absorption Rate (SAR)

Your device is a radio transmitter and receiver. It is designed not to exceed the limits for exposure to radio waves recommended by international guidelines. These guidelines were developed by the independent scientific organisation ICNIRP and include safety margins designed to assure the protection of all persons, regardless of age and health. The guidelines use a unit of measurement known as the Specific Absorption Rate, or SAR. The SAR limit for car phones is 2 W/kg. The highest SAR value for this device when tested complied with this limit.

## Installation - who should do it

The installation of this system can be carried out by yourself but please observe the installation requirements of the automotive manufacturer. During the installation, park the car at a place where the road traffic is not impaired. We recommend to let a specialised workshop perform the installation.



## Power supply

The system is designed for use in both passenger vehicles and heavy goods vehicles (HGVs). The operating voltage spans the 12 to 24 volts range. If you have queries regarding this subject, please contact our hotline.



## Position, volume

Install the components of the device in the vehicle so that your field of vision is not impaired and the components are not mounted in the impact zone of the passenger compartment or in the airbag inflation zones. The removal of coverings (with and without airbags) or components of the dashboard requires – in some cases – special tools and special knowledge.



### Intended use

We shall not be liable for damages or malfunctions due to improper use of the BURY CP 1000 CarPhone. Therefore, do not expose the device to moisture, extreme temperatures or shocks and carefully follow the procedure described in the installation and operating guidelines.



### Use while driving

Operate the system only when the situation allows it and when you do not endanger, harm, constrain, or annoy other road users. The volume of the device has to be set in a way that exterior noise is still audible.

### Faults

Do not commission the device if you detect or assume a defect. In this case, contact a BURY specialised dealer or our hotline. Improper repair efforts can be dangerous for you. Therefore, only skilled personnel may perform inspections.

### Product handling

You alone are responsible for how to use your phone and any consequences of its use.

Avoid exposure to long periods of direct sunlight when vehicle is parked as this can cause, among others, damage to the readability of the display. The sound functioning of the display is guaranteed up to a maximum temperature of 55°C.

#### Important:

- ▶ The manufacturer strongly recommends that you use the handsfree functionality of the BURY CP 1000 CarPhone at all times.
- ▶ The driver is ultimately responsible for the safe operation and control of their vehicle at all times. You should never use a hand held phone, including sending or reading text or picture messages, while driving.
- ▶ Research indicates that there is a risk to safety when the driver of a motor vehicle is distracted and using a mobile phone while driving can be a distraction.
- ▶ Full attention must be given to driving at all times in order to reduce the risk of an accident.
- ▶ Always treat your phone and its accessories with care and keep it in a clean and dust-free place.
- ▶ Please comply with the country-specific laws concerning in-car telephone calls.

## 3. Scope of supply

1



2

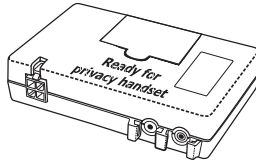

3

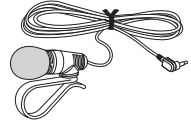

4

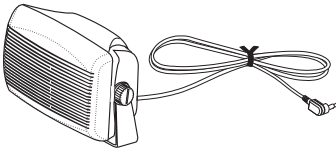

5



6

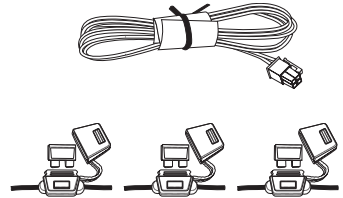

7

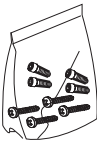

8



The BURY CP 1000 CarPhone is supplied with different combinations of components, depending on the sales regions (countries). The operating manual refers to all versions.

**Description of the components:**

- 1) BURY CP 1000 CarPhone with Vehicle Mount
- 2) Electronic box
- 3) Microphone
- 4) External loudspeaker
- 5) Strip Line Antenna
- 6) Power supply cable with fuses
- 7) Mounting accessories
- 8) Printed installation and operating manual, Quick user guide

**Note:**

► If certain components are added or omitted you will receive the corresponding information on a separate enclosure.

**Optional accessories:**

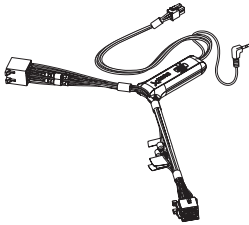

Loudspeaker switch box AC 5120

## 4. Positioning and mounting

### Step 1:

First of all, please choose the most convenient position for the BURY CP 1000 CarPhone in your vehicle by checking different positions in the vehicle.

When installing the BURY CP 1000 CarPhone avoid positioning the system where it may disrupt the proper operation of the vehicle and its components, such as car stereo, air bags, cubbyhole, glove compartment, ashtray, lighter, gear stick or hand brake.

If you would like to use the device during your journey, positioning it in the front area on the driver's side is advisable. Sit in the vehicle and check whether you can reach the device without difficulty.

After having found a suitable position for the BURY CP 1000 CarPhone in the vehicle you can now mount the BURY CP 1000 CarPhone with the Vehicle Mount.

The end of the cable with the small Molex connector is ideally suited for placing through small openings in the dashboard area. This facilitates a practically invisible installation of the cable. Take the length of the cable into account and make sure that it is of sufficient length to reach the intended location of the electronics box.

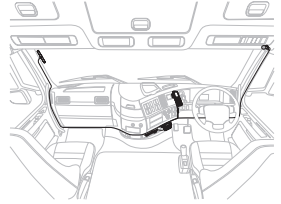

### Important:

► When positioning the BURY CP 1000 CarPhone please take care that the BURY CP 1000 CarPhone does not impair the view onto the road, that it will not be installed in the impact zone of the passenger compartment (amongst others in the airbag inflation zones) and that the cable may be laid without any problems.

► Please avoid direct sunlight on the BURY CP 1000 CarPhone or high internal temperatures, which can be rapidly reached in parked vehicles.

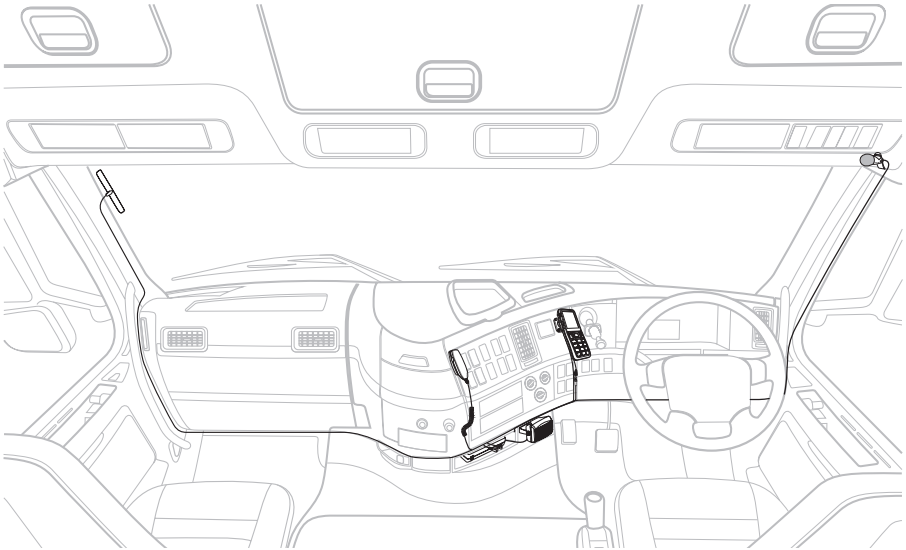
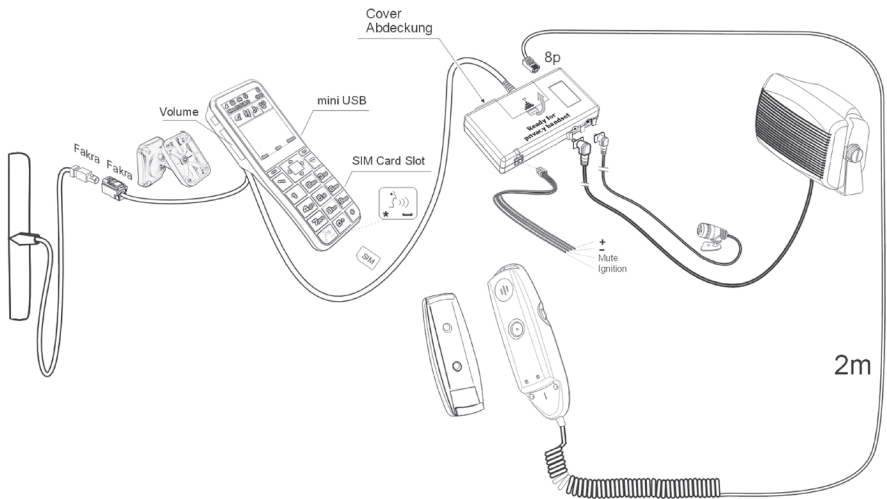

**Example of installation in the car:****Overview of all components:**

You will receive a separate manual when you purchase the handset shown.

## Step 2:

Depending on the vehicle type and its equipment (e.g. airbags), it is reasonable to install the microphone either at the A-pillar, at the sun shield or at the roof interior. For details about the equipment features please refer to the vehicle documents.

## Step 3:

Remove or loosen up cladding and covers to be able to install all of the cables in the vehicle as comfortably as possible. Please lay the cables in a way that they do not lie/hang unsecured in the vehicle and that they may not influence the conducting of the vehicle. When laying a cable, please take care that it is not under traction stress but that it has some tolerance. Avoid crushing the cable as damages of the insulation can be caused by friction/rubbing.

## Step 4:

Install the electronics box at a convenient place in the vehicle. This can e.g. be behind the radio, in the glove box, or in the centre console. Please mind that you can access the connections of the box without difficulty. It is possible that you will have to connect the components before attaching the electronics box, if it isn't possible to do this afterwards due to a lack of space. A description of the connections is provided in the next section.

## Step 5:

The preferred position for on-glass antenna is either on the upper right side or upper left side of the windshield, opposite from the driver's seat.

### Important:

- ▶ Ensure the antenna is located at least 20 cm away from driver and passengers.
- ▶ To avoid audio interference, do not thread the antenna cable close to the microphone cable.

Before connecting the components to the electronics box you should branch off the battery for safety reasons. In doing so, take into account that there might be a radio coding (confer radio manual).

### Important:

- ▶ Please install the electronics box behind a cover or somewhere you can only reach by opening or unfastening a protective cover / a cover. The electronics box must not hang loosely in the vehicle.

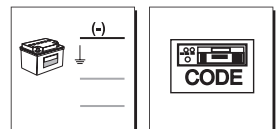
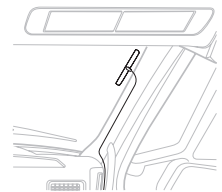
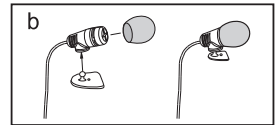
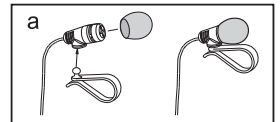
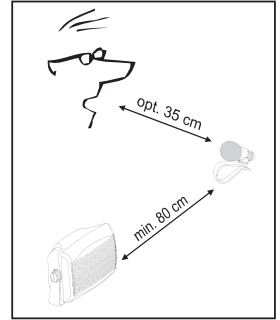

## 5. Plug the cable for the BURY CP 1000 CarPhone into the electronic box

### Step 1:

Open the top cover of the electronic box

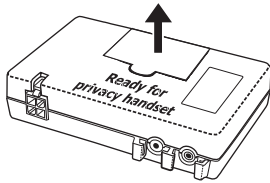

### Step 2:

Plug both jacks into the circuit board

▶ Note the coding on the jack

▶ Ensure the jacks snap firmly into place

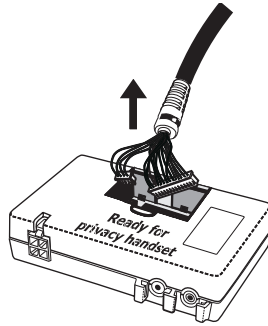

### Step 3:

Check that all components have snapped firmly into place and gently push down ensuring they are below the level of the top cover position

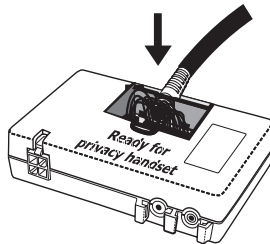

### Step 4:

Carefully close the top cover of the electronic box, ensuring no wires get trapped in the process

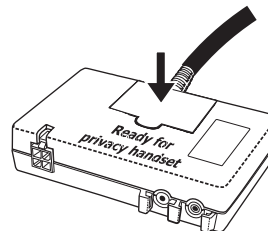

## 6. Connections on the electronics box

The additional components of the BURY CP 1000 CarPhone are connected to the electronics box. The following connections are provided:

### Connection options:

- 1 Power supply
- 2 External loudspeaker
- 3 Microphone
- 4 BURY CP 1000 CarPhone

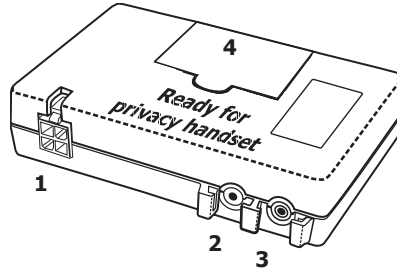

### 1 - Power supply

The power supply of the BURY CP 1000 CarPhone is established via a 4-core cable. Connect the black (clamp 31 – minus), the red (clamp 30 – steady plus) and the blue cable (clamp 15 – ignition plus) to the power supply of your radio (where required via the cigarette lighter or the fuse box). After connection to the counterpart, the yellow cable provides for radio muting during a phone conversation. Please connect the white Molex connector with connection 1.

#### Note:

► Do not connect your device to the power supply or switch it on until instructed to do so in the installation instructions.

#### Attention:

► If you also connect the blue cable to clamp 30 (steady positive), the BURY CP 1000 CarPhone will be permanently supplied with power. If the vehicle is not running for a longer period, this could lead to a discharge of the car battery.

► If you deviate from the specified connection descriptions it may be the case that certain functions on the BURY CP 1000 CarPhone (e.g. the on-call duty) will not function correctly.

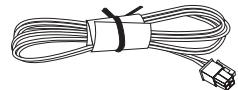

## Installation instructions for the fuses

Please cut through the red, the black and the blue cable by means of a wire cutter. Now insert the two endings of the red cable resulting from the cut into one of the binders, then close it. If you hear two clicking noises, the clamp snapped in properly. Now insert one of the fuses and then repeat the procedure with the other cables.

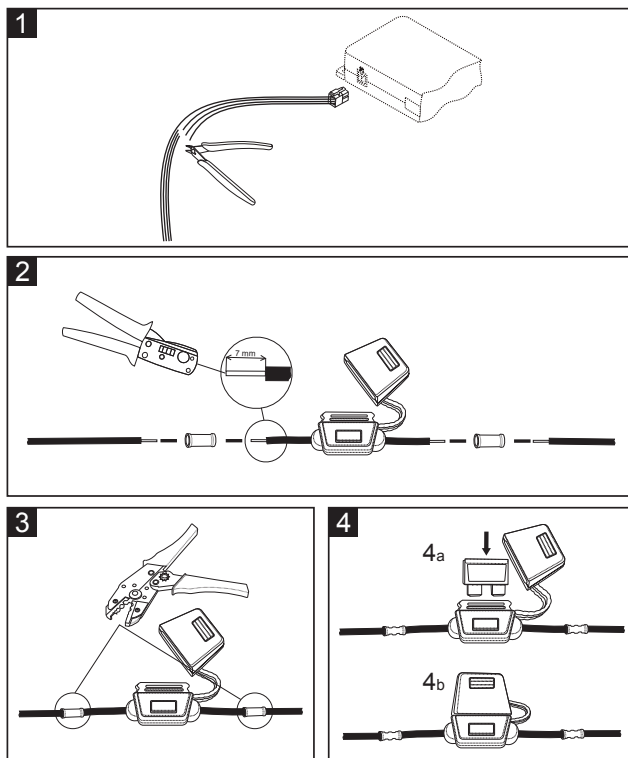

## 2 - External loudspeaker

Connect the external loudspeaker here if you do not want to or are not able to make use of the vehicle's own sound system. When installing the loudspeaker, make sure it is positioned the correct distance from the microphone.

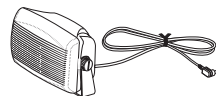

## 3 - Microphone input

This is where you plug in the microphone jack.

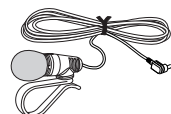

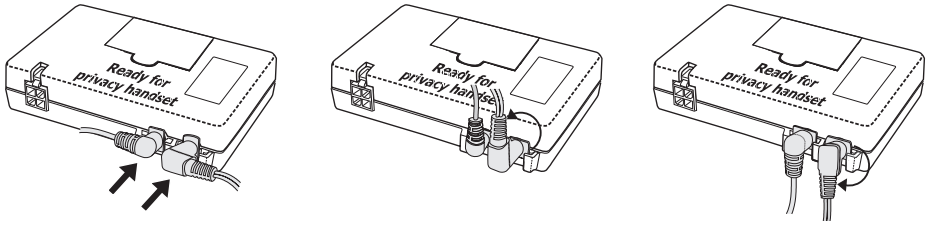

#### 4 - BURY CP 1000 CarPhone

This is where you connect the BURY CP 1000 CarPhone.

#### SIM card protection

The plastic cap that is used to protect your SIM card can be used once only.



#### Note:

►The device may be damaged if you try to remove the plastic cap.

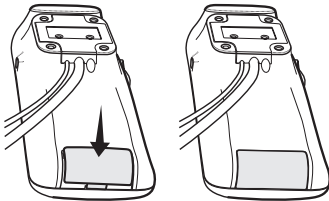

Optionally, you can also protect your SIM card with a removable rubber cap.

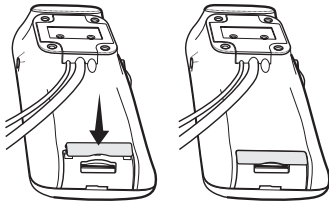

## 7. Using the BURY CP 1000 CarPhone for the first time

The BURY CP 1000 CarPhone offers you an extremely convenient in-car telephone solution. As well as a 2.8 inch display and a well-spaced keypad, the clear and easy-to-read car phone also has a SIM card slot which allows it to function as a fully stand-alone communication system.

Description of the main system:

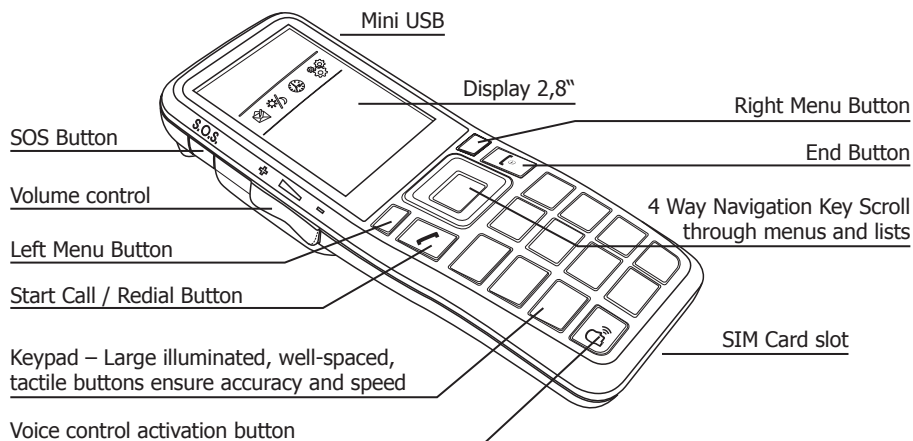

### Important:

► The device operates in GSM 850/900/1800/1900 MHz frequency bands.

Output power:

Power Class 4 (+33dBm ±2dB) for EGSM 850

Power Class 4 (+33dBm ±2dB) for EGSM 900

Power Class 1 (+30dBm ±2dB) for GSM 1800

Power Class 1 (+30dBm ±2dB) for GSM 1900

### Activating your SIM card

Insert the SIM card into the SIM card slot while the BURY CP 1000 CarPhone is switched off.

► Avoid touching the SIM card's metal surface

### Switching the BURY CP 1000 CarPhone on and off

After the power supply of the BURY CP 1000 CarPhone is successfully connected, the system is activated when you have started the vehicle. The car phone can be switched on and off manually by pressing the End button.



### Adjusting the volume

Use the volume control to adjust the ring volume when no calls are active. Use the volume control to adjust the call volume during a call.

### Entering your PIN

Now enter your PIN. Your PIN (Personal Identification Number) protects you against unauthorised use of your telephone card by third parties.

#### Note:

► If you enter the wrong PIN three times you will need your PUK number to unlock your card.

Afterwards you will reach the head menu. Different symbols will appear in the top row. These symbols have following meaning:

- Missed calls / New messages
- Signal strength of the telephone network
- Activation of voice control

The symbols on the display have the following meanings:

- Day/Night mode
- Call lists
- Contacts
- Messages
- Settings
- Date/Time
- Memo

### Choose language

After this, you have to select the menu language if several are available for you to select. Regional differences may occur in this context. If the system is only equipped with one language then this should load automatically. You can change the menu language again by selecting **Settings** in the **Head menu**, and then changing the **Language** in the **Phone** menu item.

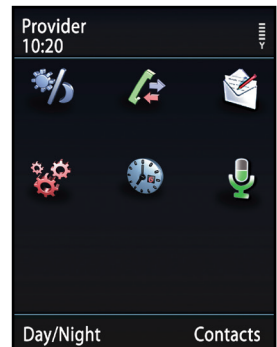
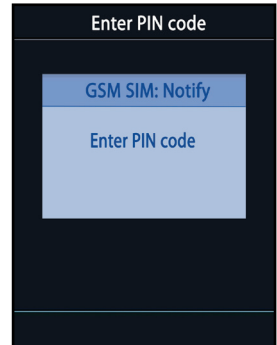



## 8. Handling possibilities

The system can be operated in two ways:

1. Operation using voice control

The **"VOICE COMMANDS"** are highlighted in the further explanatory notes.



Voice control

2. Operating the menu using the keypad

## 9. Voice control

The menu items of the system can be selected using voice commands once this function has been activated. There are exceptions, however, when you still have to use navigation key scroll. During an active telephone call, for instance, you can't use voice commands. You have to select any additional functions using the keypad.

To start the voice control feature, press this button. If the Magic Word function is activated, you can also start the voice control by stating the **"ACTIVATE VOICE DIAL"** command. In certain situations, however, with an incoming call and activated voice recognition for instance, the BURY CP 1000 CarPhone will start the voice control system automatically. The system signals that it is ready to receive a command by emitting an acoustic signal.







If you aren't sure of the right command to use, then simply state **"HELP / WHAT CAN I SAY"**. The BURY CP 1000 CarPhone will then read out the commands available for the particular menu in which you currently find yourself. If the BURY CP 1000 CarPhone fails to understand one of your commands, or the particular option isn't available, the help function will start automatically and list the possible commands. When entering voice commands, please ensure you speak naturally, clearly and at a regular speed.

### Note:

► With the use of the voice control it is recommended to turn down the volume of components which are independent of the audio system (e.g. a navigation system) or to switch off the broadcast of traffic jam warnings in order to avoid unintended voice entries.

In addition to these commands, the BURY CP 1000 CarPhone recognises the numbers from zero to nine. Numbers which are larger than nine must be spoken individually (e.g. 10 = one, zero). To search in the contacts, the BURY CP 1000 CarPhone recognises the letters "A" to "Z" as well as the NATO alphabet. For the entry of telephone numbers abroad, the command "PLUS" is also available.

When using voice control, in **all menus** these four commands are always available:

|   |           |  |
|---|-----------|--|
|  | Cancel    | breaks off the current action          |
|  | Head menu | back to head menu                      |
|  | Back      | one step back                          |
|  | Help      | names all commands which are available |

## 10. Operating the menu using the keypad

You can also operate the BURY CP 1000 CarPhone using the illuminated and well-spaced keypad. The keypad offers the following options:

Use the End button to end a call or leave the selected menu page.



Use the Start call button to accept a call or to redial.



Use the menu buttons on the left and right hand sides to open the corresponding menu displayed.



Use the navigation button in like a joystick to navigate through the menu system and to change settings.

Use the SOS button to make an emergency call. You can pre-set the number to call in an emergency in the menu settings.

## 11. Menu navigation

Here you will find all menus which are necessary for the operation and configuration of the system. These can be selected through the keyboard or using voice control.

You are also able to select additional frequently used commands via voice control which otherwise first appear later in the menu tree. These are as follows:

**"DIAL JOE BLOGGS",**

**"READ NEW TEXT MESSAGE".**

If the voice control function is active then the corresponding menu appears in the display, or the details of the particular function that has been activated. In the following the individual menu points will be explained.

### Dial Joe Bloggs

With this voice command (is not shown on the display) you can immediately call a contact from your telephone book with active voice control.



Dial Joe Bloggs

**Note:**

►When doing so, it is important that the stated name exactly corresponds with the entry stored in the phonebook. Please note that telephone book entries, which are only shown in capital letters must be spelt out. Example: ADAC.

If the names have been reversed then the command changes to: **"DIAL BLOGGS JOE".**

## Dial number

It makes sense to divide telephone numbers in short number blocks of 3-4 digits and to say them this way. At each break, the BURY CP 1000 CarPhone repeats the number block and waits for the next number block. After the signal tone you can respectively continue your announcement.

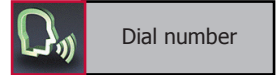

Enter the area code. Enter the first numbers of the actual telephone number. Enter the remaining numbers of the actual telephone number. When you have entered the last number block of the telephone number, you can check the complete telephone number once again with the voice command **"PLAYBACK"**. Here are some more commands:

The complete entry will be deleted, or the previous entry.



The last digit is deleted.

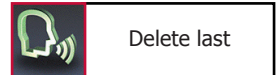

A telephone connection is being established.



The last number block will be deleted.

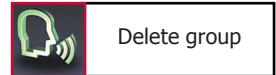

## Contacts

The entire list is read aloud to you. With **"STOP"** you can stop the process and select the respective entry. With **"NEXT"** or **"NEXT PAGE"** and **"PREVIOUS"** or **"PREVIOUS PAGE"** you can navigate in the list. With **"DIAL"** the telephone connection will be made. You can also jump directly to one of the entries shown by activating the entry number. E.g.: **"SELECT ENTRY THREE"**.



You can save names and phone numbers to the memory of the SIM card (SIM directory) and to the internal memory of the car phone. Depending on your provider, up to 250 contacts can be stored to the SIM card, while 1500 contacts can be stored to the internal memory.

You can also subsequently save a number that called your phone or from which you received a text message. You do not have to enter the number all over again.

<Joe Bloggs> is a placeholder for an entry from your contacts. If you select a name, you go directly to the respective entry.



Here you can search for entries through a letter field. Read out the first letters of the first name and surname (depending on the sort sequence) which you want to find. The corresponding letter appears in the top line and will also be read out to you again.

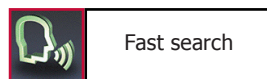

If several names are available in your contacts with the letter you entered, then you can limit your search further and enter up to three additional characters for the quick search. Via the display, you get the information highlighting which additional letters the BURY CP 1000 CarPhone finds in your contacts. The rest is correspondingly greyed out.

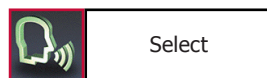

Via the **"SELECT"** command you can confirm your input. The display then shows you the contact with the entry which best matches your input. With the commands **"DELETE LAST"** or **"DELETE ALL"** either the last letter or all of the letters you entered are deleted.



Via the **"GET DETAILS"** command, you will find all of the telephone numbers that are listed under this contact.

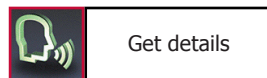

In addition you can allocate a contact with an own voice command (voice tag). This is recommended for names which are difficult to pronounce. In these instances, the use of nicknames or abbreviations is recommended.

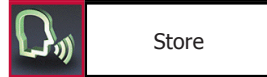
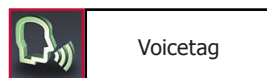

Clearly speak the command into the microphone, the BURY CP 1000 CarPhone repeats this and you can then make a call to the desired discussion partner from the head menu with e.g. **"CALL CUSTOMER ONE"**.



In all the BURY CP 1000 CarPhone can store 150 voice commands. This voice command (voice tag) is valid for all numbers which are allocated to this contact name. A corresponding inquiry follows about which of these numbers you want to call.

**Note:**

► In order to make voice recognition easier for the BURY CP 1000 CarPhone, please do **not** use voice commands for **your** voice commands (voice tags) which are also used by the system.

## Redial

The number which was last selected can be selected once again.



## Call lists

Here in a chronologic sequence all calls are listed which have been made, missed or accepted. The name of the caller / the person being called and the telephone number are displayed. If it is not possible to allocate a contact to the telephone number, the number alone appears without additional information. You can have the telephone number read to you and if you want call back. The navigation within the lists is carried out analogue to that of the contacts.



## Messages

Using this function, you are able to show and to read out text messages via the BURY CP 1000 CarPhone.

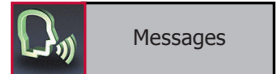

The text messages will be displayed in the overview in the format with which you are familiar from the call lists. The name of the sender is shown in the upper line and underneath this, the date and time of when the message was received.

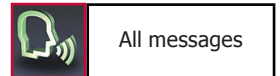

The envelope symbol appears in the status bar of the main menu for your information when a new message has arrived. You can select these straight from the main menu with the commands "**READ NEW MESSAGE**".

If you want you can call the sender back.

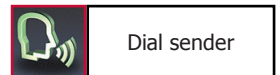

## Sending text messages

You can also use the BURY CP 1000 CarPhone to send your own SMS. The text message can be entered easily using the keyboard.

## Settings

In this menu point, you can configure the BURY CP 1000 CarPhone through four further submenus. These are **Voice dial**, **Audio**, **Display** and **Phone**.

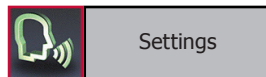

## Voice dial

In this submenu you can carry out the following settings:

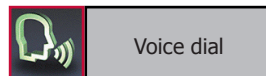

### Activation or deactivation of the magic word:

If you activate this function you can start the voice controlled operation of the BURY CP 1000 CarPhone straight from the main menu with the preset voice command "**ACTIVATE VOICE DIAL**". With this function, you are able to leave both your hands on the wheel. To indicate that you are able to activate the BURY CP 1000 CarPhone using the magic word, the voice control symbol appears in the display.

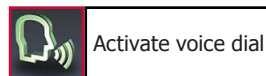

### Note:

► If you state this command during a conversation with a passenger or this passage should be read out over the radio for instance, it is possible that the voice control function will be unintentionally activated.

### Activating or deactivating the Advanced Help feature:

If you activate the advanced help, then in certain menus you receive additional assistance during voice control operation about the commands which you are able to use. With other commands, the system will ask you if you really want to complete them.

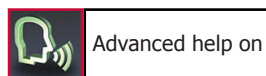

### Activating or deactivating the Audio feedback:

If you activate the audio feedback, during the keypad operation you receive voice support (e.g. the contacts entries and all of the message windows are read aloud to you). Your selection is shown through an information field.

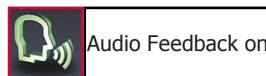

The BURY CP 1000 CarPhone works in general independent from the speaker, that means it can immediately be operated without a 'voice training'. Then user training is only needed if you speak a strong dialect. The system reads twenty terms aloud to you which you have to repeat so that the system can get used to your voice.

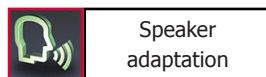

Here you will receive short instructions about the essential functions of the BURY CP 1000 CarPhone.



## Audio

In this area you have the possibility to change the audio settings of the BURY CP 1000 CarPhone.

The BURY CP 1000 CarPhone is sold with four **Ringtones** from which you can respectively select one. With **"NEXT"** or **"PREVIOUS"** you can navigate in the list. With **"SELECT"** the ring tone is selected.

The volume level for the voice feedback and the selected ring tone can be set in an additional sub menu. The volume of the beeper that gives the signals for speed control and for the hazardous zones can also be set here in the same way. Available as voice commands are **"LOUDER"**, **"LESS"**, **"MAXIMUM"**, **"MINIMUM"** and **"ACCEPT"**.

For some radios it may cause problems if the BURY CP 1000 CarPhone starts with voice response immediately after the mute signal. Some radios need some time for a corresponding activation and reaction to the mute signal. This will be indicated to you through the fact that you don't hear the signal tone at the start of the voice control. To avoid this effect, you can enter a maximum delay of up to three seconds in the **"MUTE DELAY"** menu item. It is only after this time has elapsed that the BURY CP 1000 CarPhone begins with the voice feedback.

## Display

This menu point makes it possible for you to adjust the display in a range of different ways.

In order to avoid the blinding effect especially when driving at night, you can activate the **Sleep mode**. This causes the display to shut off after either 15, 30 or 60 seconds. With an incoming call, the BURY CP 1000 CarPhone activates the display automatically.

In the **Illumination** menu item you can change the intensity of the light diodes in the display. As voice commands **"MORE"**, **"LESS"**, **"MINIMUM"** or **"MAXIMUM"** are available. The confirmation follows with **"SELECT"**.

To be able to read the contents of the display optimally during different light conditions, in the next menu item, **Day/Night mode**, you are able to invert the display.

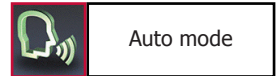
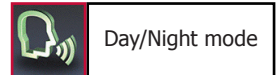
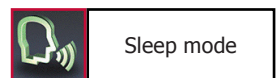
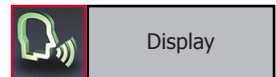
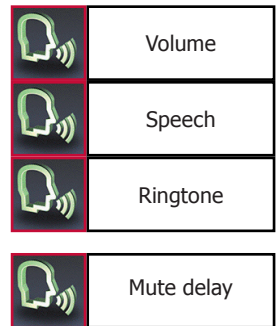
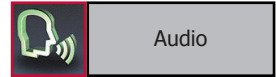



## Phone

In the phone menu item, you can make the settings concerning the answering of calls, the menu languages, the PIN code, the number presentation, the GSM, the settings of date and time, for the system itself, and for the willingness to answer calls.

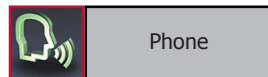

With the call answering function you can specify as to whether you want to answer an incoming call manually via the keypad, by voice command, or automatically. If you select automatic call answering, the call will be answered automatically after two rings. You can then not decide to decline the call.

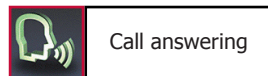

Depending on the sales regions (countries) the BURY CP 1000 CarPhone includes one or several language packages. If several are available you can select the suitable **Language** which you want.

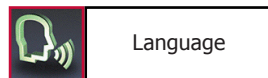

### Note:

► The BURY Service offers the possibility change or add language packages. This service is available for an additional charge. You can get more information via the BURY hotline. Their contact details are provided at [www.bury.com](http://www.bury.com).

You have to set the language when you use the device for the first time and after updating the firmware.

### Pin code

You are able to assign an individual **"PIN CODE"** in the next menu item. Your own code must be at least four figures long – with a maximum of eight being allowed.



### Note:

► If an error message with the note regarding an incorrect PIN entry appears, the cause--apart from the possibility of the incorrect input--could lie with the SIM card itself. SIM cards of many network providers do not allow the deactivation of the PIN code prompt. This can be because they are older or because this function was blocked at the request of the network provider.

Here you can activate the fixed dialling function. If the FDN mode (FDN = Fixed Dialling Numbers) is activated, only previously defined phone numbers from the SIM card can be dialled. The PIN2 code which you have received from your provider is required to activate this function. Direct dialling from the contacts list is no longer possible when the FDN function is activated.

The phone list for the FDN function can be reviewed and activated / deactivated by using the PIN 2 code. The number of FDN contacts you can store to the SIM memory depends on the SIM card (at least 9 and up to 50 contacts).



Fixed dialling

You can then assign the numbers 0-9 to the defined phone numbers and you can call the contact simply by pressing the corresponding number.

**Note:**

- ▶ If the FDN mode is activated, you can only send an SMS to a number that is stored in the FDN contacts.
- ▶ To send text messages to the SIM contacts while the fixed dialling service is active, you need to add the text message centre number to the fixed dialling list.

**Short dialling**

Short dialling enables you to make phone calls at the touch of a button and to send short messages. There are eight numeric keys (keys 2 to 9), which can be assigned a short dialling number.



Short dial

**Tip:**

- ▶ Set the short dialling keys on the basis of your own preferences. One preference might be, for instance, the younger the person, the lower the value of the numeric key to which the speed dial is allocated.

The BURY CP 1000 CarPhone has an integrated digital signal processor (DSP). This serves the functions of voice recognition and voice synthesis and is activated as standard. Together with the suppression of background noise and echoes, the DSP guarantees optimum conversational sound quality. You can completely deactivate the DSP.



DSP

**Number presentation**

Using the **Number presentation** menu item, you are able to select as to whether the BURY CP 1000 CarPhone sends the details of your own number along during an outgoing telephone call or not. Here, you have a choice of two options: **Show number** and **Hide number**. Your telephone number will then consistently either be hidden or sent.



Number presentation

**GSM power off**

In this menu you can adjust the GSM.



GSM power off

## Date/Time

Here you can set the date and time. You can choose between different formats.



Under the **System** heading, you receive information about the software and hardware installed in the BURY CP 1000 CarPhone under **Version info**. If a new item of firmware should become available for the BURY CP 1000 CarPhone, then under the menu item **Software update** and using the BURY Update Suite, you are able to update the system.

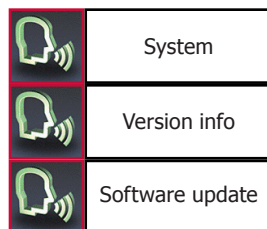

### Note:

▶ Do not interrupt the power supply of the BURY CP 1000 CarPhone during an update.

▶ We recommend to let the firmware update be carried out by a BURY specialist retailer. Details of your nearest specialist retailer are provided at [www.bury.com](http://www.bury.com).

If you have changed certain settings but the BURY CP 1000 CarPhone doesn't work in the way in which you wanted it to, then you can reset the BURY CP 1000 CarPhone to the settings which were stored in it when you received it using the **Factory setting** function.

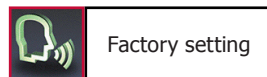

Using the **On-call duty** menu item, you are able to activate the BURY CP 1000 CarPhone's internal standby switch. When activated for the first time, this is set at 5 minutes. It can be changed to 10 or 15 minutes, however.

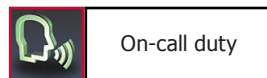

On-call duty is useful if you stay in your vehicle after reaching your destination or switch the engine off when waiting at level crossing, for instance. The BURY CP 1000 CarPhone remains active for a set period of time, and you can still conduct telephone conversations. In the event of no active phone call, the BURY CP 1000 CarPhone will then switch off automatically after the set time has elapsed.

In this menu you can enter the number for the emergency call. This phone operates using radio signals, which cannot guarantee connection in all conditions. Therefore, you must never rely solely on any phone for emergency communications.

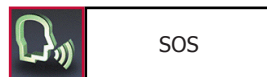

## Memo

If you want to make a note of something important either after or during a trip or maybe during a telephone call, it is often the case that you don't have anything to write with at hand or the traffic situation prevents you from doing so. With this function you are able to save information that is important to you without posing a risk to yourself or others.

A voice memo can be saved directly from the main menu or during a telephone call. **Private** and **general** voice memos are differentiated between.

It is possible to save up to 10 voice memos. The column that moves from left to right during the recording indicates the remaining recording time that is available. The current recording time is also displayed in the same way. The maximum possible length of the memos totals two minutes. If the recording time has run out, this will be displayed accordingly. To be able to record additional memos, you then have to delete the old ones.

In the list, the memos are numerated from 1 to 10 so you can initialise them with the voice control feature using the command **"NOTICE 1"** or simply **"1"**. Underneath this, you can see the recording time that this memo takes up. Any memo that is made during a telephone call is always a private memo.

### Note:

► When recording telephone calls, please take the privacy of your conversational partner into consideration and tell them that you would like to record parts of the telephone call.

Examples of **private** memos are addresses, telephone numbers or internet sites which you want to make a note of for later during your journey or during telephone calls.

You can also create a **general** voice memo. The maximum recording time totals two minutes. If the memo is not listened to before the BURY CP 1000 CarPhone is switched off, then after it is switched on, a message appears via a pop-up stating that a voice memo which has not yet been listened to is available. If the Audio Feedback is activated this message is also read out.

If a **general** voice memo is already available and you would like to record a different one, you will be asked whether you would like to overwrite the old memo. The maximum recording time totals two minutes.

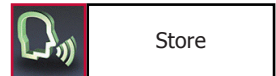

**General** voice memos are especially suited to vehicles which have continually alternating drivers, e.g. delivery vehicles. This means that the next driver can be instructed accordingly if someone forgot to refuel or the vehicle has a flat tyre, preventing it from being driven.

## 12. Accepting, making, ending calls

You will be alerted of an incoming call via the voice output and the ring tone. Your vehicle's sound system will switch onto mute. If the caller sends their telephone number with the call, this will be shown in the display unless the number is saved in your phone. If an entry for the number is saved in your phone, then the name of the caller will be read out. If the caller hides their number, this will be indicated in the display.

In the standard setting, you can only accept or decline an incoming call via the keypad. If you would like to accept the call, simply press on the Start call button. If you don't want to accept the call, please press the End button.

During the call, you have the possibility to regulate the volume of the voice of your discussion partner through the volume control.

**Note:**

► Please comply with the country-specific laws concerning in-car telephone calls.

With the **Memo** sub menu, you are given the option of being able to record part of a telephone call. Please refer to the relevant part of the operating instructions for a detailed description.

Use the End button to end a call.

If a telephone conversation is active when you switch off your vehicle's engine, the BURY CP 1000 CarPhone will remain running until the call has been ended.

## 13. Service

In case of general or technical queries, suggestions and comments, please do not hesitate to contact our team at any time. Suggestions and feedback are always welcomed:

**Administration:**  
**BURY GmbH & Co. KG**  
**Robert-Koch-Straße 1-7**  
**D-32584 Löhne**  
**GERMANY**

**Producer:**  
**BURY Spółka z o.o.**  
**ul. Wojska Polskiego 4**  
**39-300 MIELEC**  
**POLAND**

Hotline: +49(0)180 6 - 842 468\*

E-mail: [hotline@bury.com](mailto:hotline@bury.com)

\* 0.20 €/min. Deutsche Telekom AG landline. The costs of international telephone calls which are made from abroad can vary.

### **Warranty / Service desk:**

The duration of the warranty for the components of this product totals two years subsequent to the date of sale to the end customer. Any warranty claims you may have as an end customer are to be asserted towards your contractual partner. If the corresponding contractual partner is not able to rectify a corresponding fault, please exercise your rights of purchase. If subsequent to agreement with your contractual partner the product is to be sent directly to the manufacturer, then please send it, along with a detailed description of the fault in the German or English language and a copy of the proof of purchase, directly to our service team:

**BURY GmbH & Co. KG**  
**Im Hause DPD Depot 103**  
**Robinienweg**  
**D-03222 Lübbenau**  
**GERMANY**

### **Information on the disposal of electrical goods in the EU**

The crossed out wheellie bin symbol means that electrical and electronic products, batteries and accumulators must be disposed of separately in the European Union. Please do not dispose of any such products in your normal household waste. As the owner of a product of this sort you are legally obliged to dispose of it at your local dumping site or recycling centre, where you are able to leave your waste electrical goods free of charge.

## 14. Approvals and declaration of conformity

At BURY, purchase, production, as well as distribution and service, follow environmentally friendly processes according to the ISO 14001 Standard and Quality Management Requirements, according to the ISO/TS 16949 Standard. The device has

**CE** Hereby, BURY declares that this device BURY CP 1000 CarPhone is in compliance with the essential requirements and other relevant provisions of Directive RED 2014/53/EU.

**RoHS** This product meets the requirements of the European directive 2011/65/EU on the restriction of certain hazardous substances in electrical and electronic equipment.

You can request a conformity declaration from the manufacturer of this product by writing to the following email address: [ce\\_conformance@bury.com](mailto:ce_conformance@bury.com). It is also available on our web site [www.bury.com](http://www.bury.com) in the downloadable files section of a given product.

Version: 06/2017

25.1407.0-07-270617

Subject to change. Errors and omissions excepted.

All use of these brands by BURY Technologies takes place within the scope of the corresponding licence. All of the other stated brands are owned by their corresponding owner. All rights reserved.